

# MERLIN

## szekréénysor

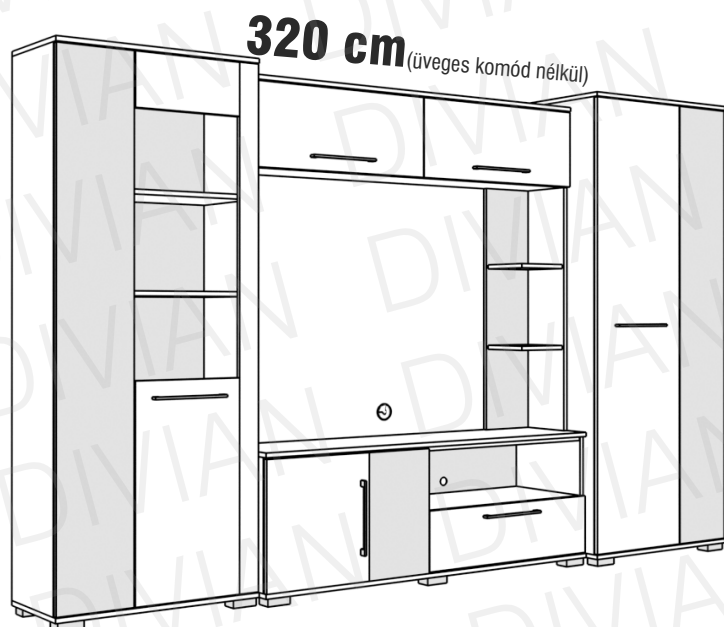
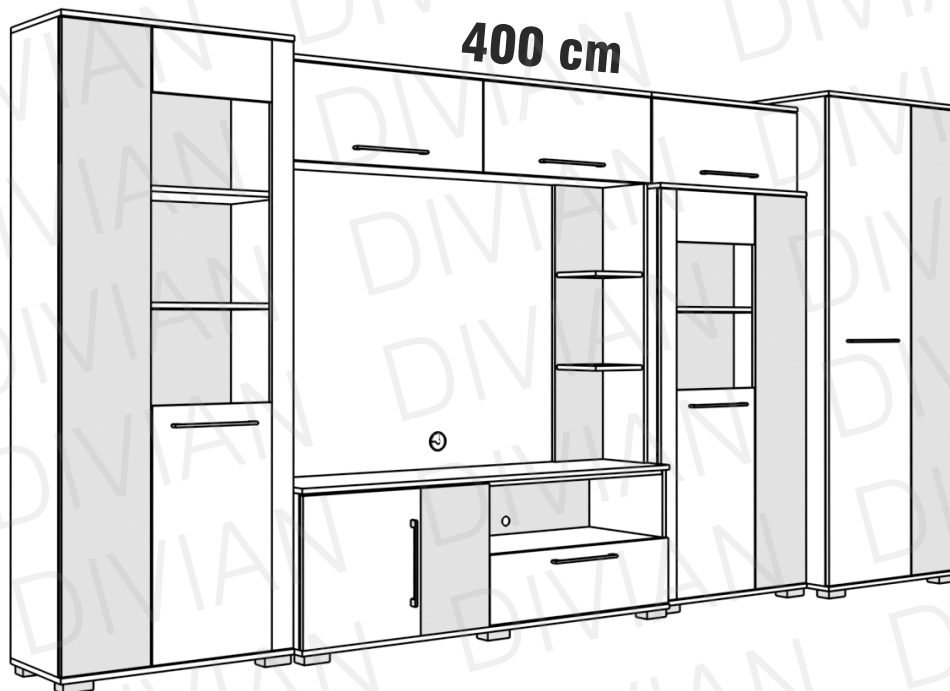

## SZERELÉSI ÚTMUTATÓ

## Szekrény csomag tartalma:



bútorösszehúzó M6x30 12db

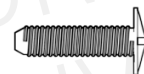

bútorösszehúzó M4x12 12db



polctartó 24db

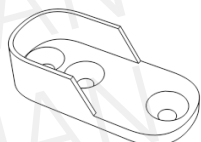

rúdtárcsa 2db



3,5x16 csavar 4db



Konfirmátor csavar 4db

## Szükséges szerszámok:

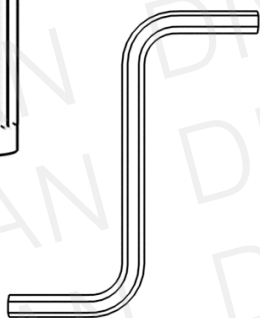

## Ne egyedül végezze az összeállítást!

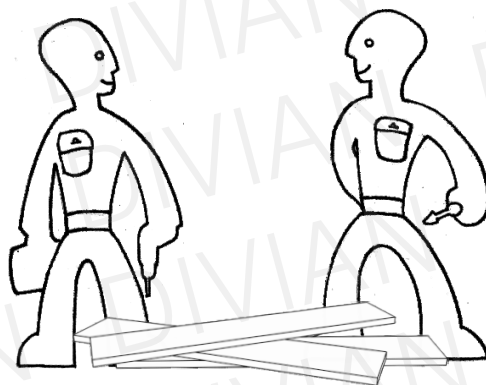

Óvja az elemeket a sérülésektől!

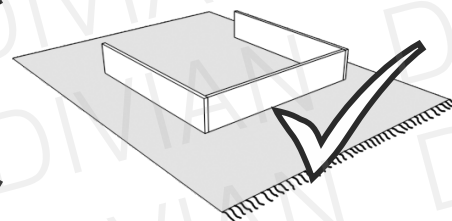
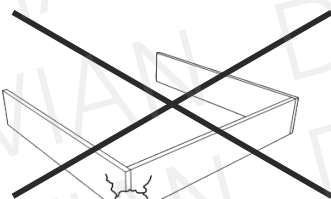

A csomagok több alkatrészt tartalmazhatnak, mint amennyire szüksége van!

# ELEMEK

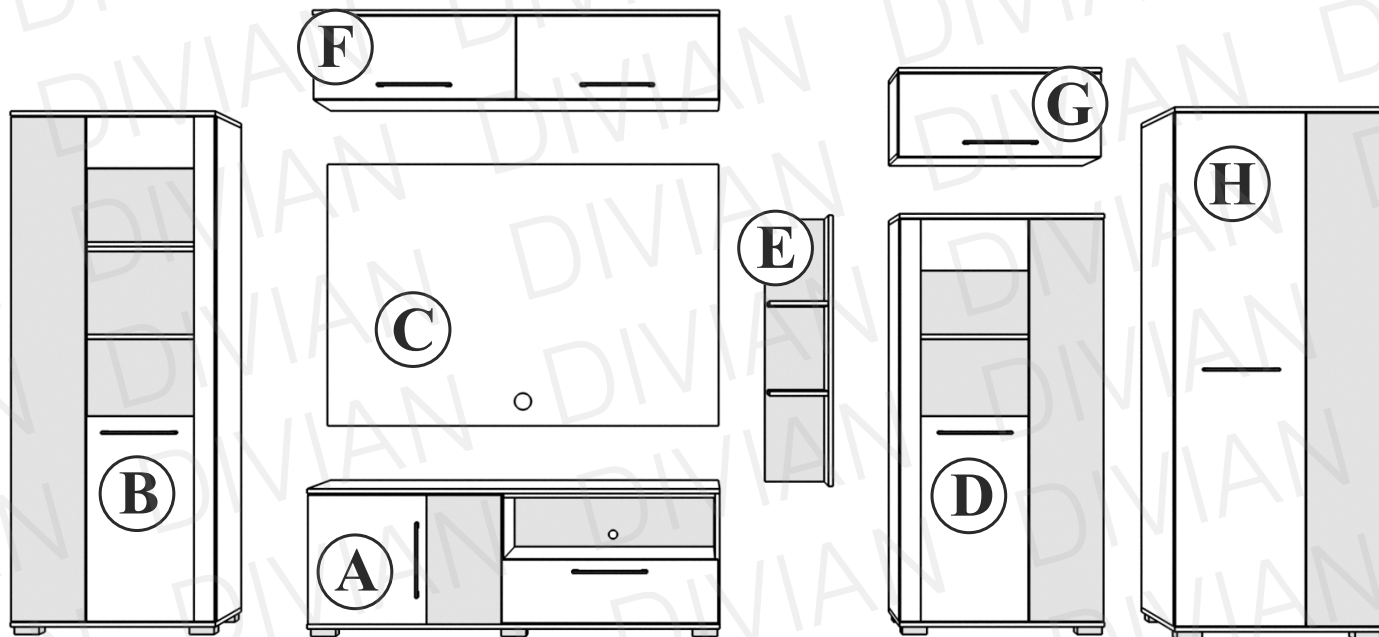

**i** Merlin szekrénysor 320 (ruhás nélkül) cm: A;B;C;D;E;F;G  
 Merlin szekrénysor 320 (üveges komód nélkül) cm: A;B;C;E;F;H  
 Merlin szekrénysor 400 cm: A;B;C;D;E;F;G;H

A könnyebb áttekinthetőség érdekében a szerelési útmutatóban az adott elemeket ajtók nélkül ábrázoljuk. Az összeszereléshez Önnek természetesen nem szükséges levennie az ajtókat!

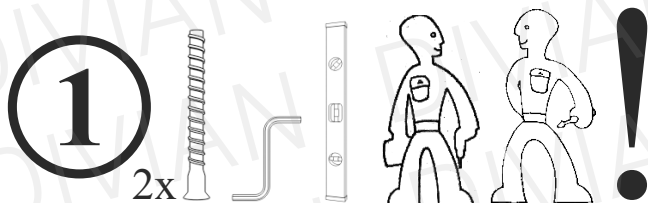

**i** Hátfalak síkban legyenek.

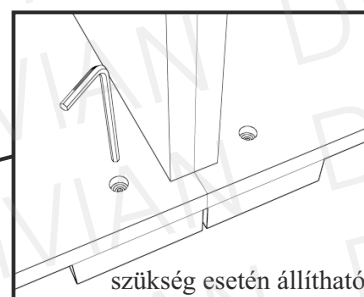
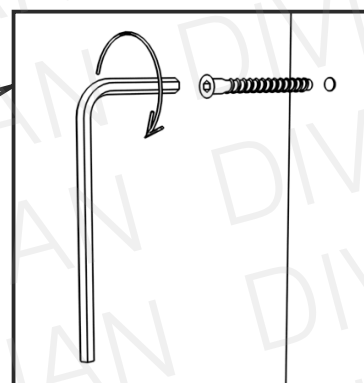
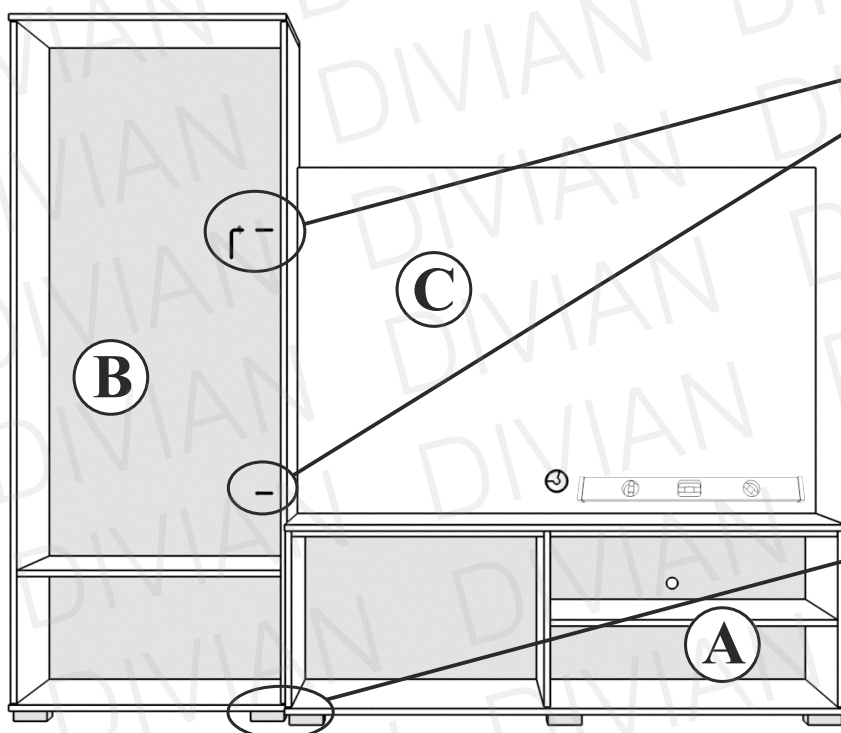

2

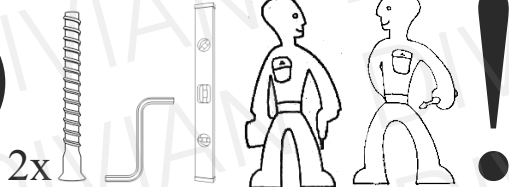

i

Amennyiben 320 cm-es (üveges komód nélkül) méretet vásároltak, lapozzanak az 8. oldalra, és a 10. ponttól folytassák a szerelést.

i

Hátfalak síkban legyenek.

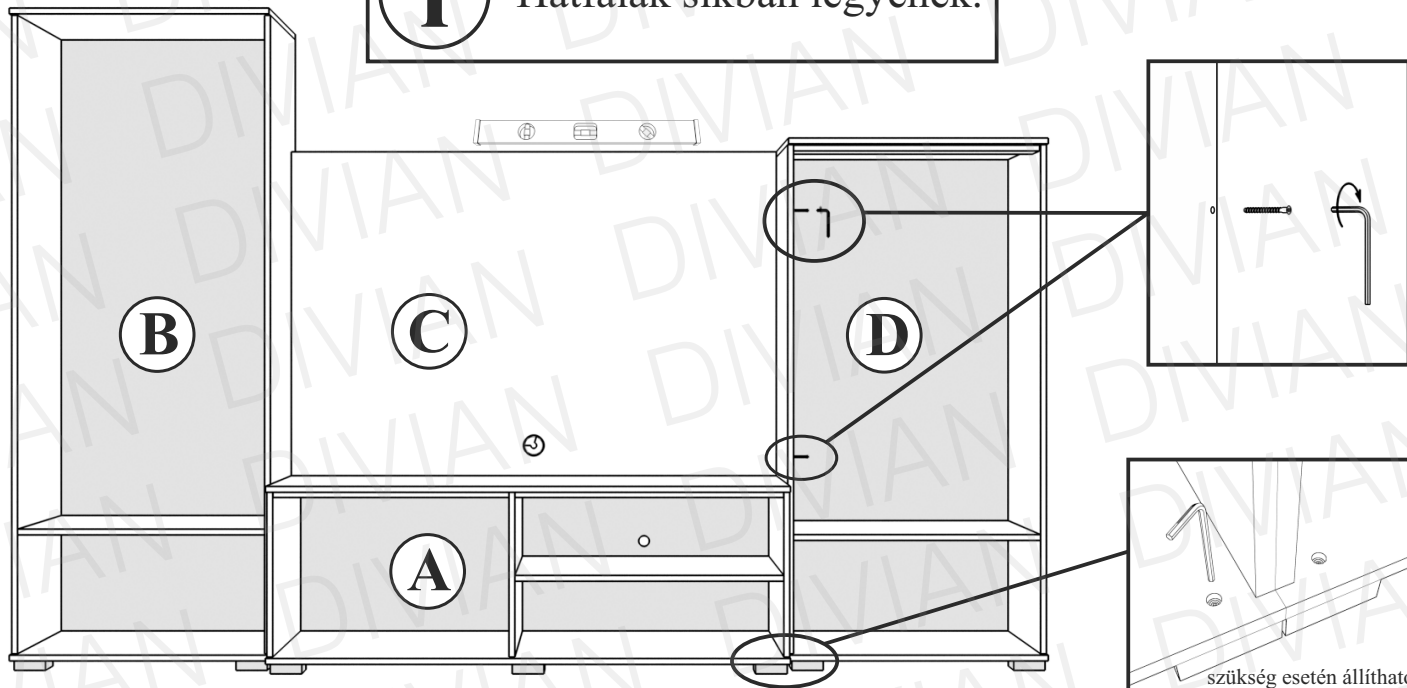

3

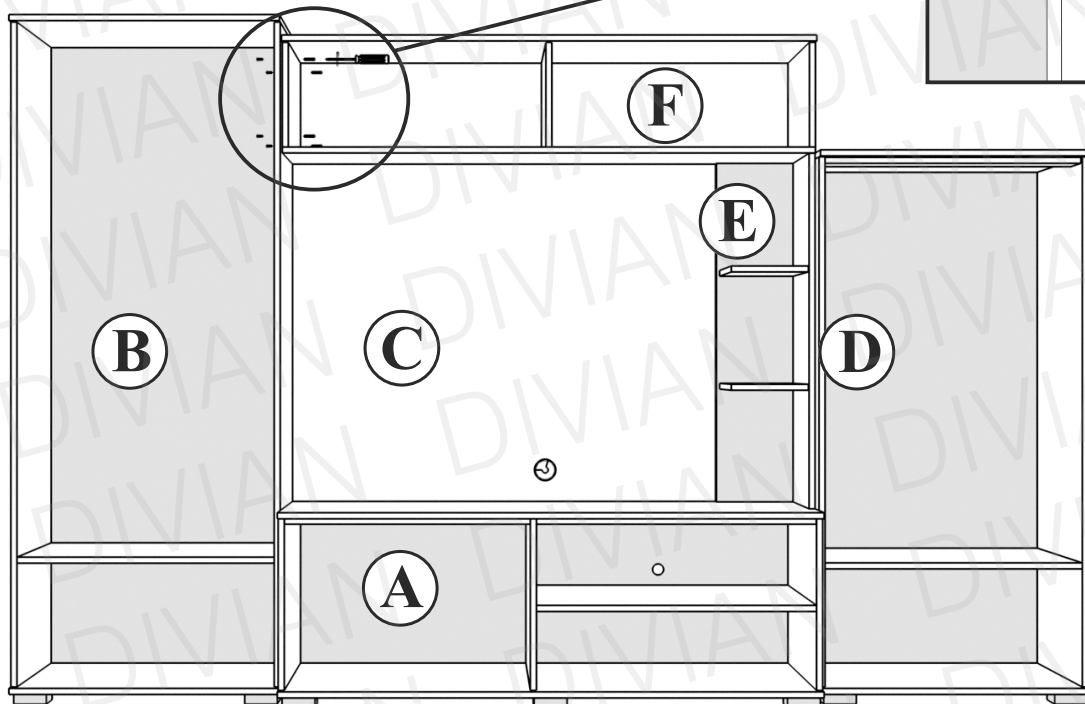
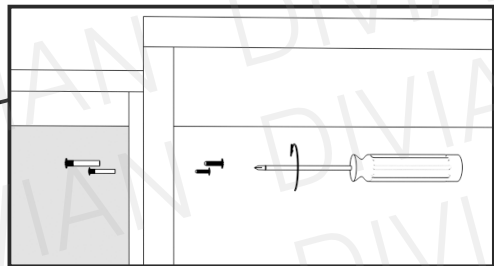

**4**

4x M5x30 4x M4x12

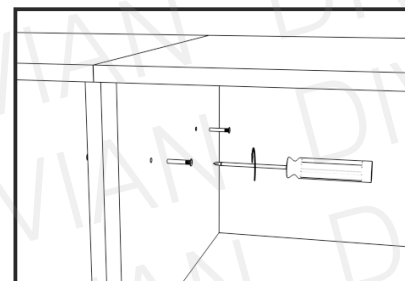
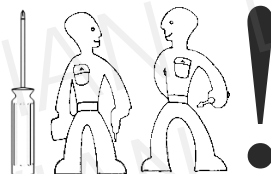

**i**

Amennyiben 320 cm-es (ruhás nélkül) méretet vásároltak, az elemek összeszerelése ezzel a ponttal véget ér. Lapozzanak a 6. oldalra, és a 6. és 7. pontnál látottak alapján illesszék be a polcokat.

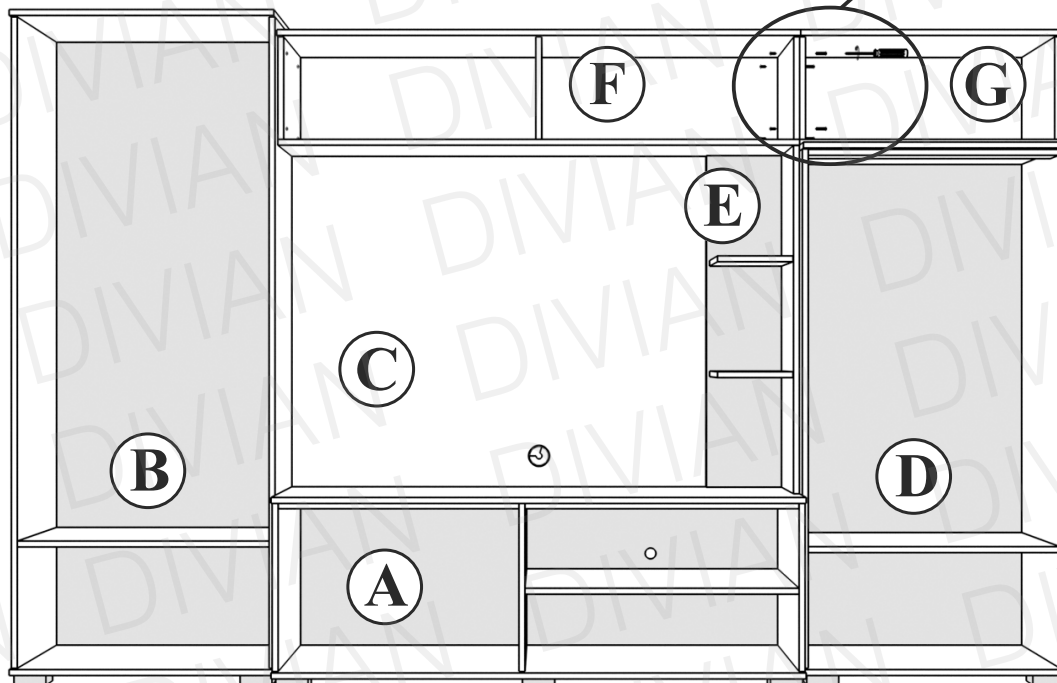

**5**

4x M5x30 4x M4x12

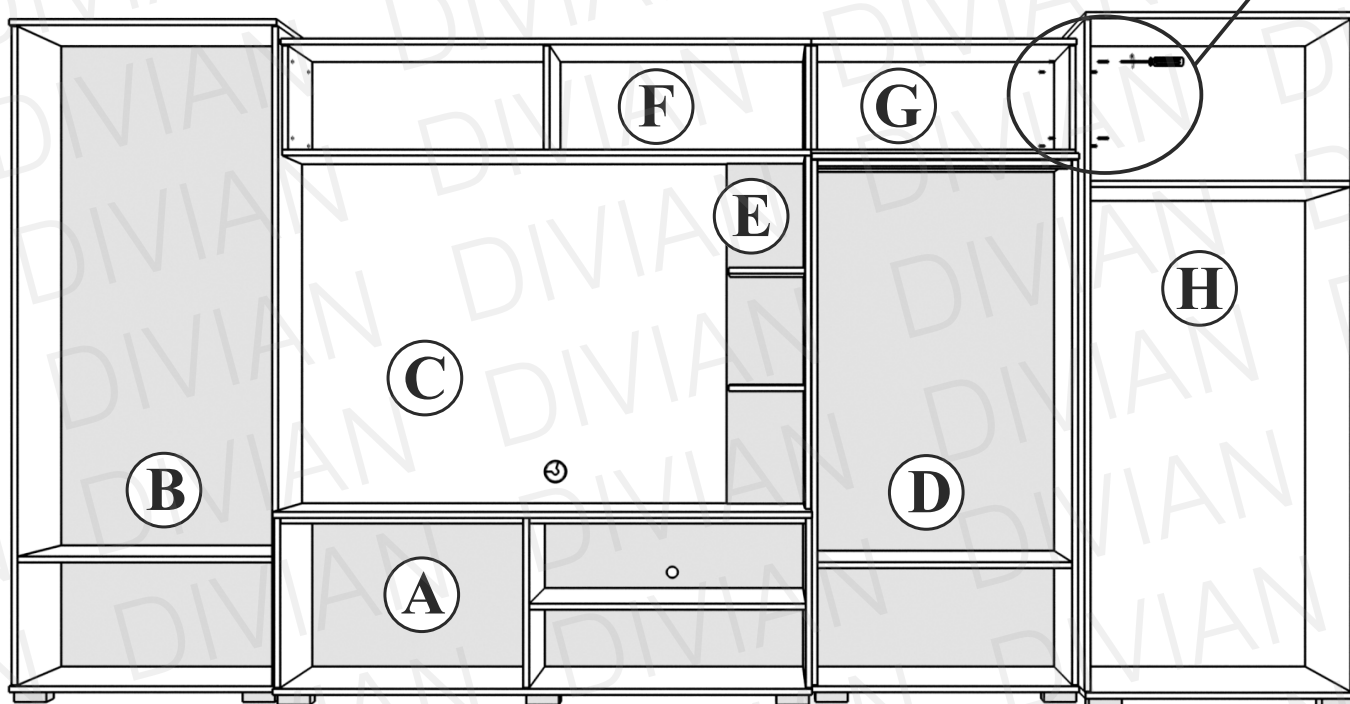
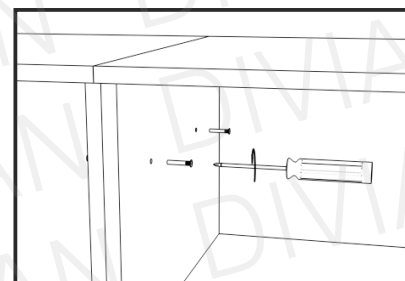
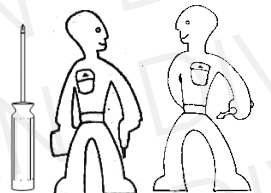

**6**

24x



Helyezze be a polcokat a szekrény sorba a polctartók segítségével.

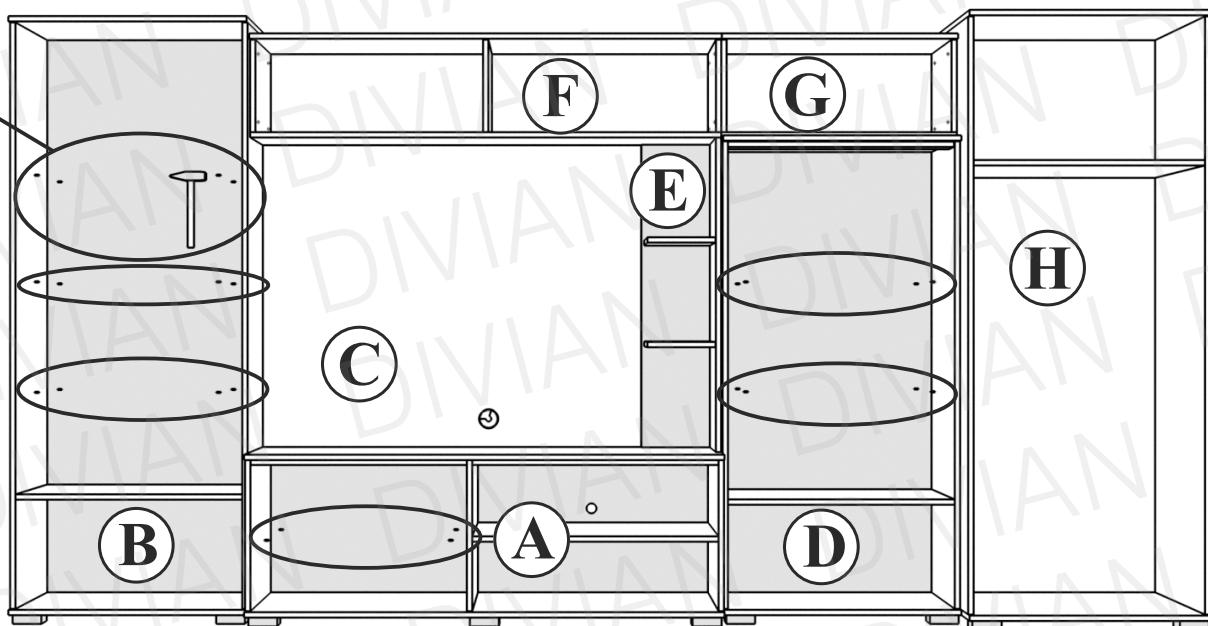
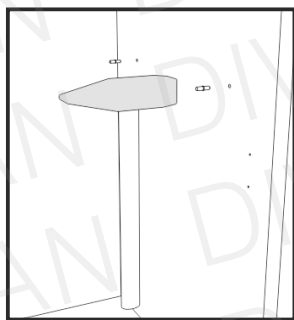

Amennyiben vásároltak LED világítást, azokat még a polcok behelyezése előtt tegyék be a B és D elembe. A ledek szereléséhez szükséges alkatrészeket, a LED dobozában találja.

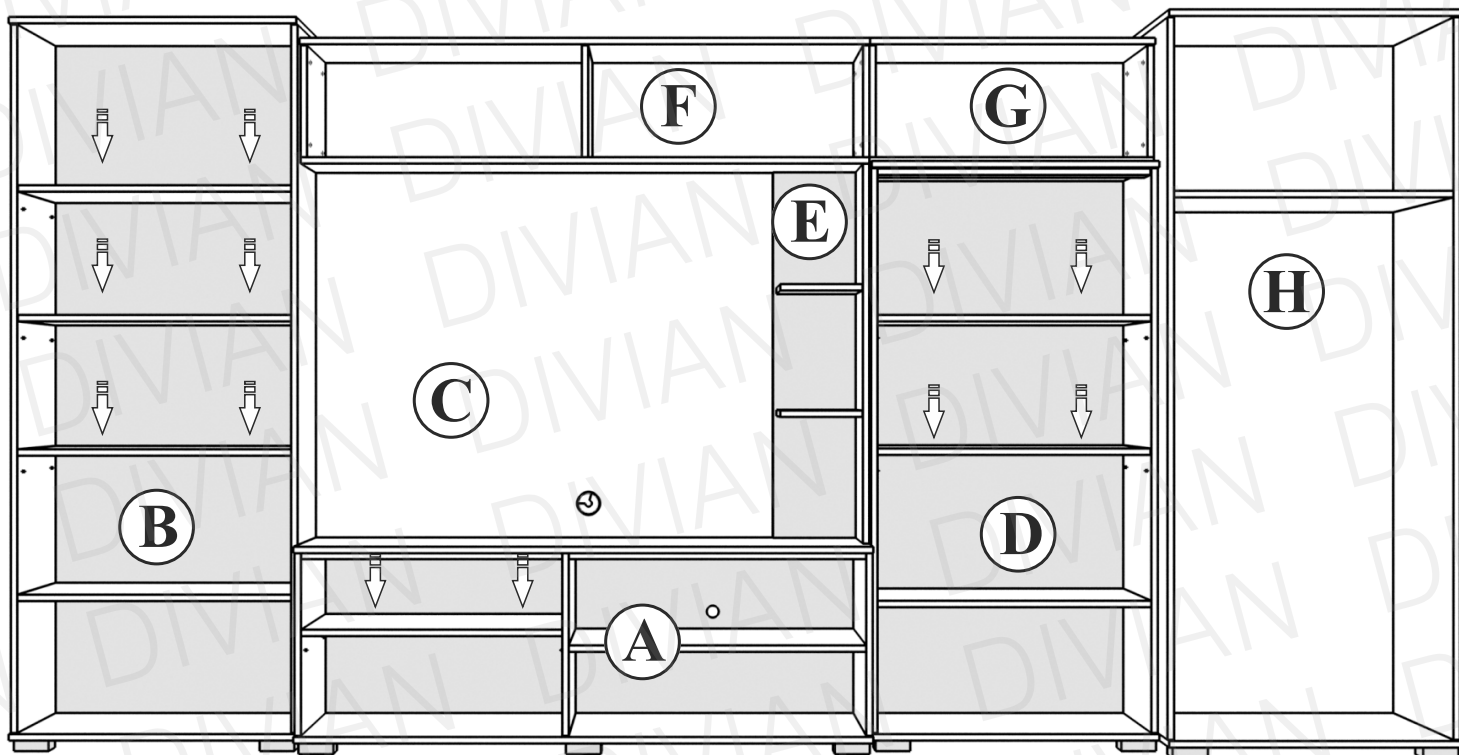
**7**

8

2x



4x

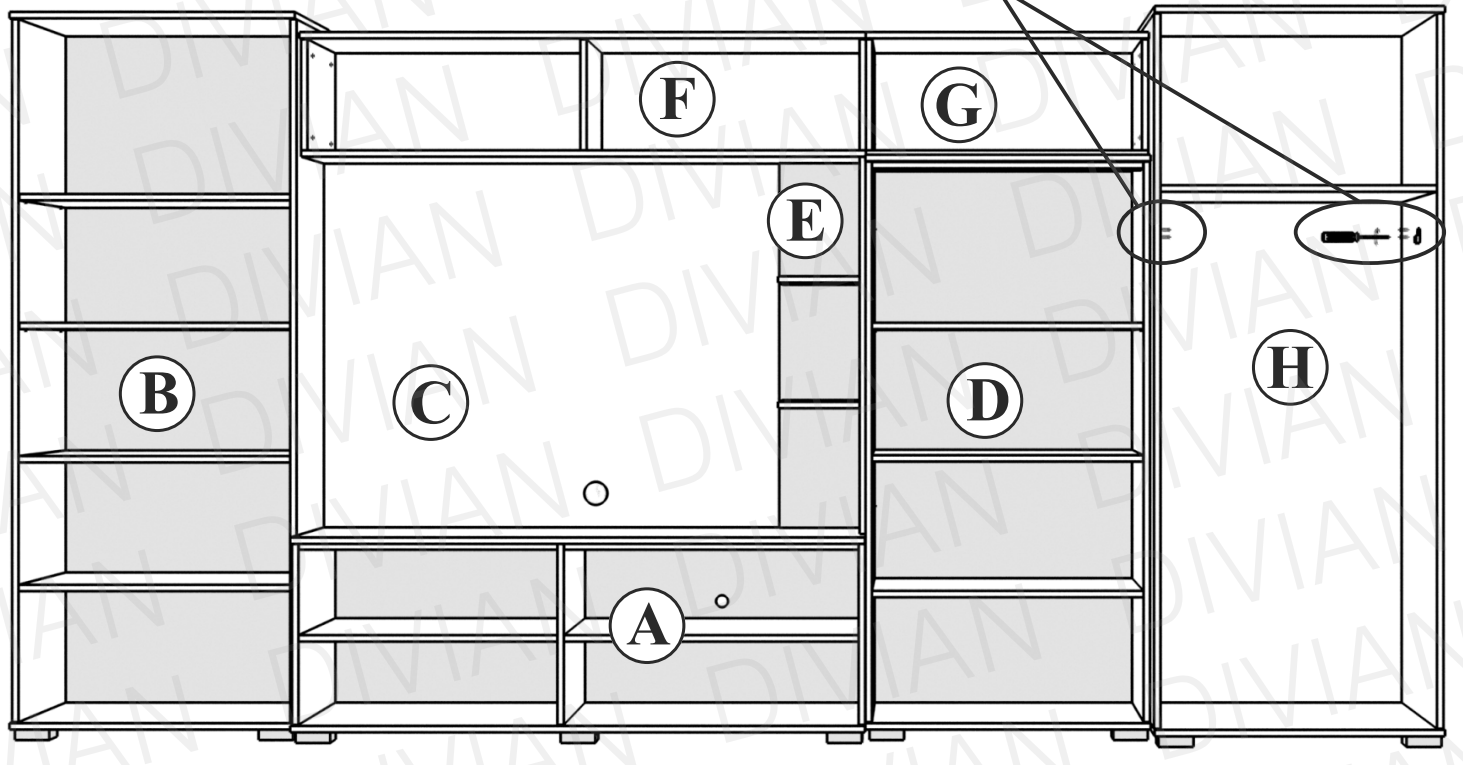
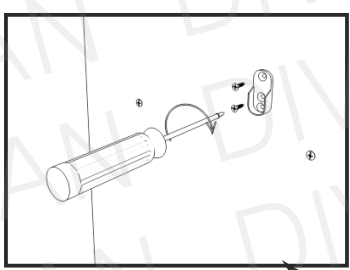
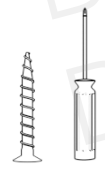

9

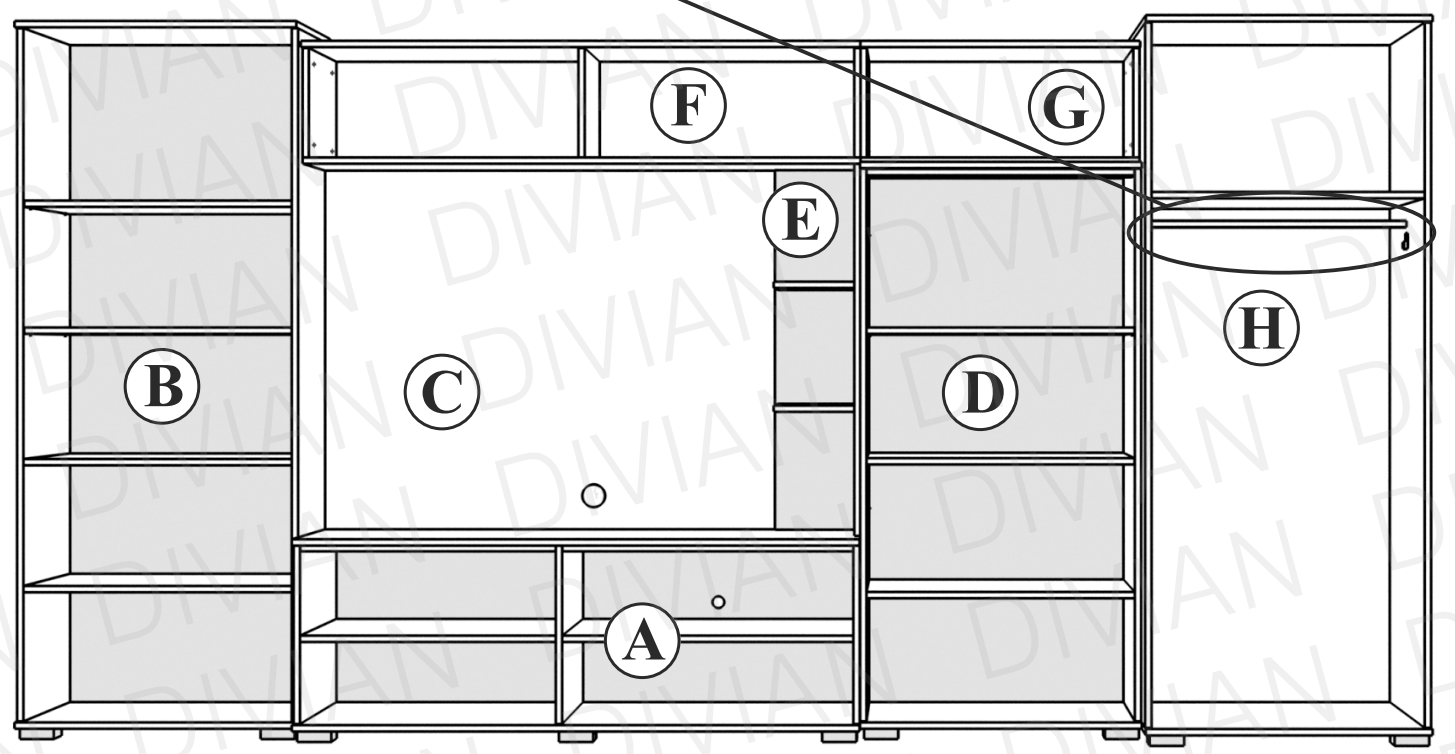
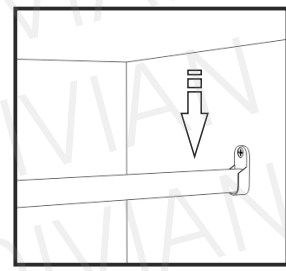
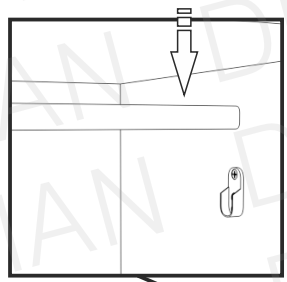

10

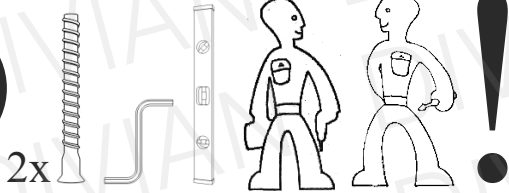

i

Az alábbi lépésekben a 320 cm (üveges komód nélkül) méret szerelését követhetik.

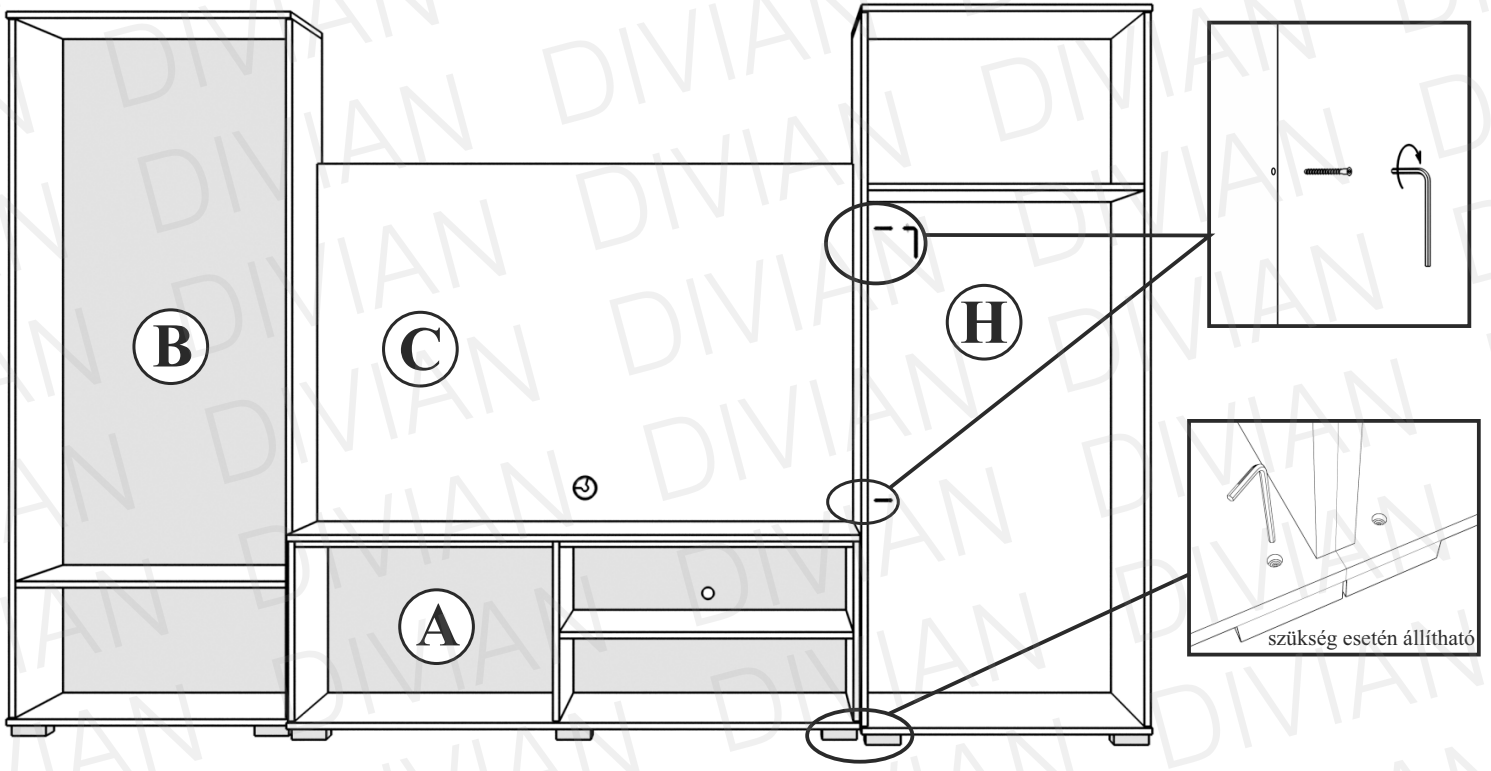

11

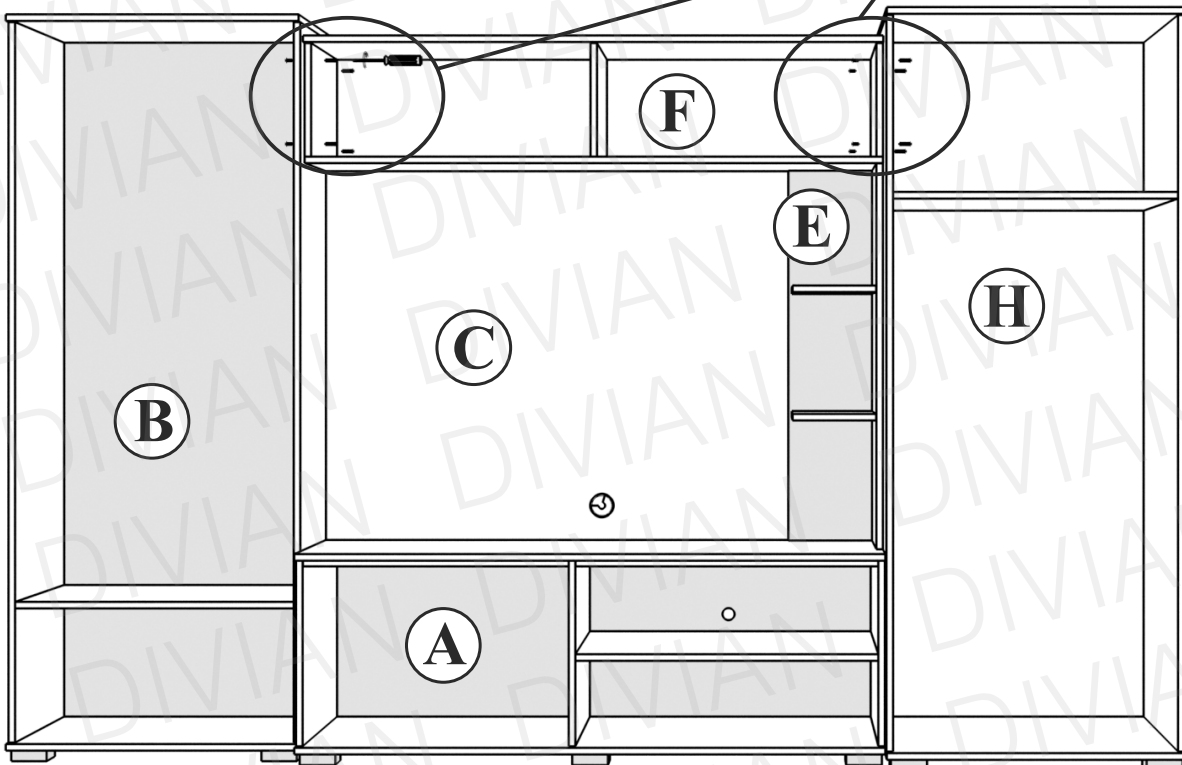
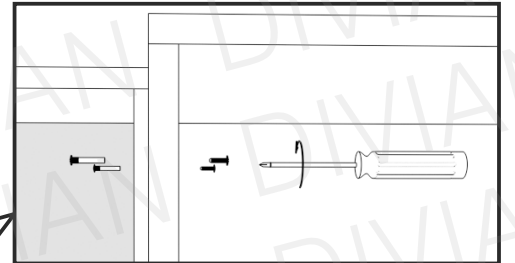



**12**

16x

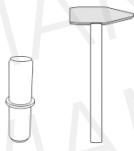

Helyezze be a polcokat a szekrény sorba a polctartók segítségével.

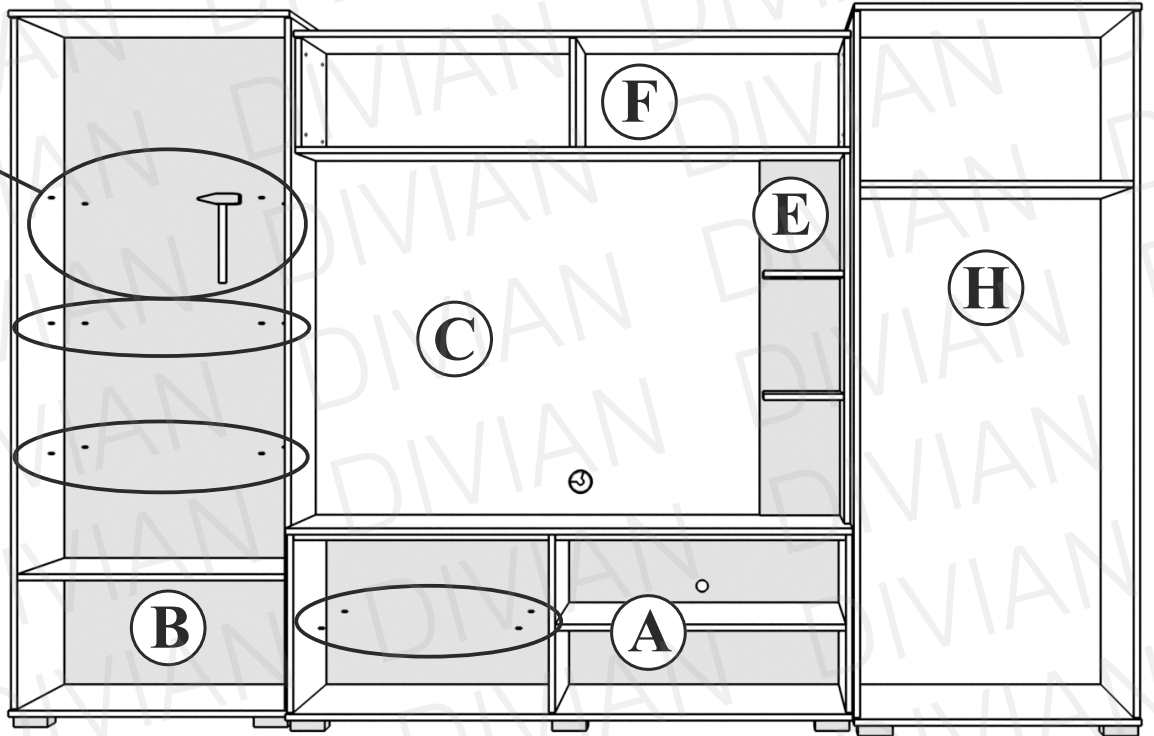
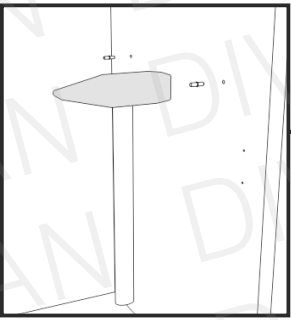
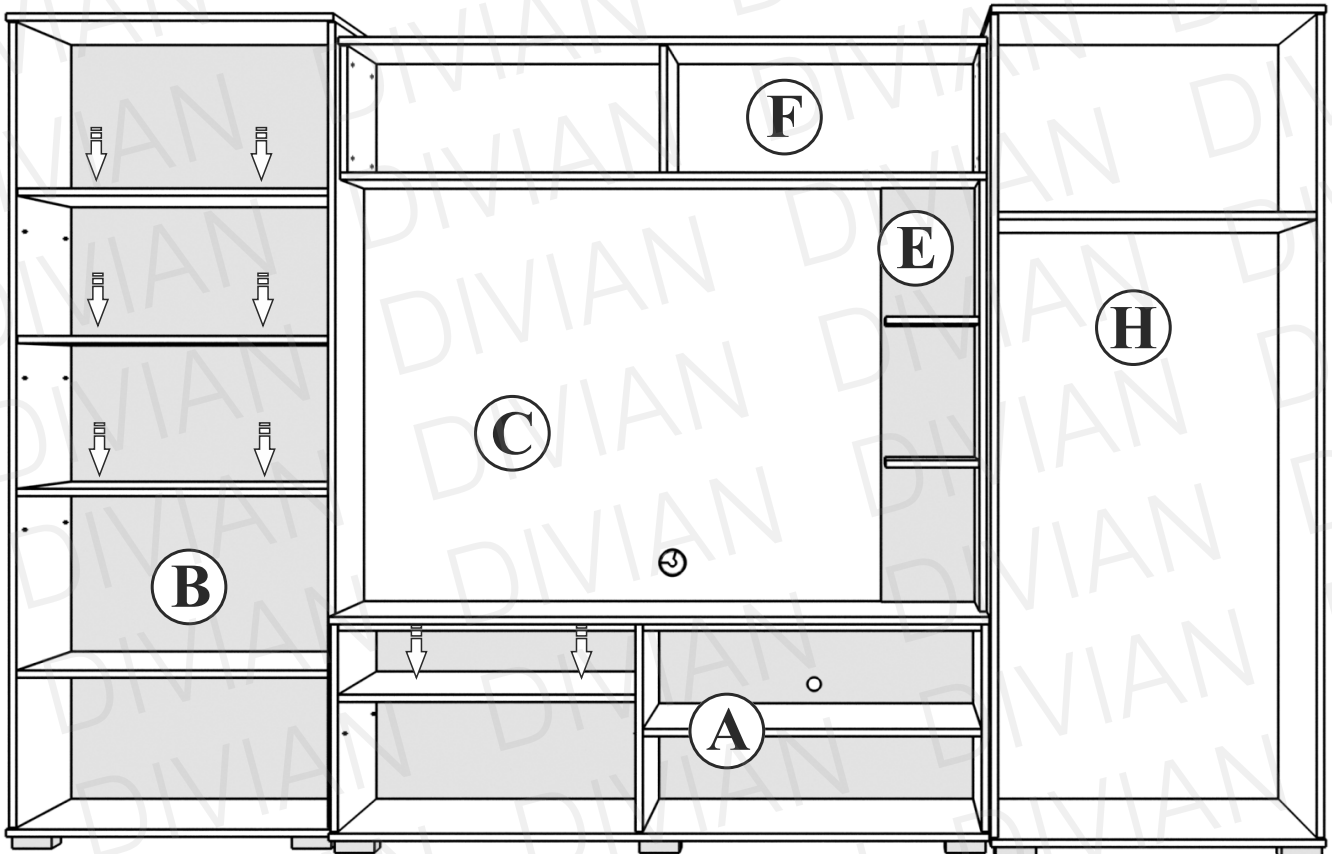
**13**

**14**

2x



4x

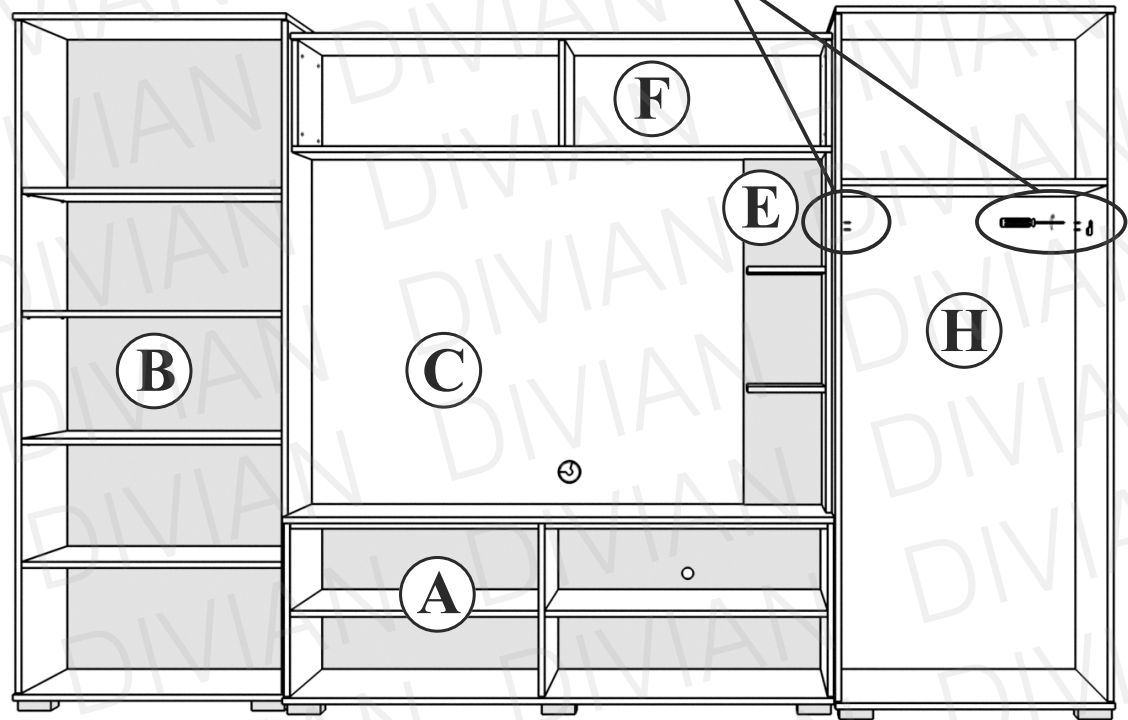
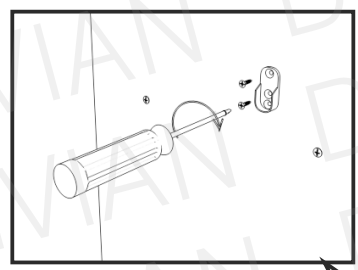
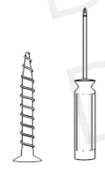

**15**

